



REQUEST FOR BIDS

Boyne City Main Street is accepting bids to fabricate four artistic bicycle racks for the City of Boyne City's downtown area. The designs are included with this request.

These are year-round functional sculptures. They must be of the highest quality and craftsmanship. The racks will be in a very public setting and must not pose any safety risk to the pedestrians. There can be no sharp or rough edges and welds must be secure.

In your bid include the following:

- The type, size, gauge, diameter, etc. of metal to be used in construction. Racks may be in aluminum or steel. Base plate needs to be large enough to accommodate 4 anchor bolts (1/2" dia. min.). They can not have sharp edges.
- Finishing – describe how the raw metal will be prepped, what type of finish will be used, and number of coats applied. A list of the paint / colors (plus manufacture info) for each sculpture needs must be provided for each sculpture. (Please make note of any guarantee on the finish).

Installation will be by the City, but delivery is the responsibility of the bidder.

Timeline

Bids Due:	August 30, 2013
Contract Awarded:	Mid September, 2013
Delivery:	To be negotiated

Submission Requirements

Please submit (1) hard and one (1) digital copy of proposal. Please include the following:

- Cost to produce each design.
- Digital or hard copy images of previous work that is similar to this project.
- Client references.

Submit materials no later than 5 PM on August 30, 2013 to:

Boyne City Main Street
Hugh Conklin, Manager
112 S. Park Street, Suite F
Boyne City, MI 49712

If you have any questions, contact Hugh Conklin at 231-582-9009 or via email at mainstreet@boynecity.com

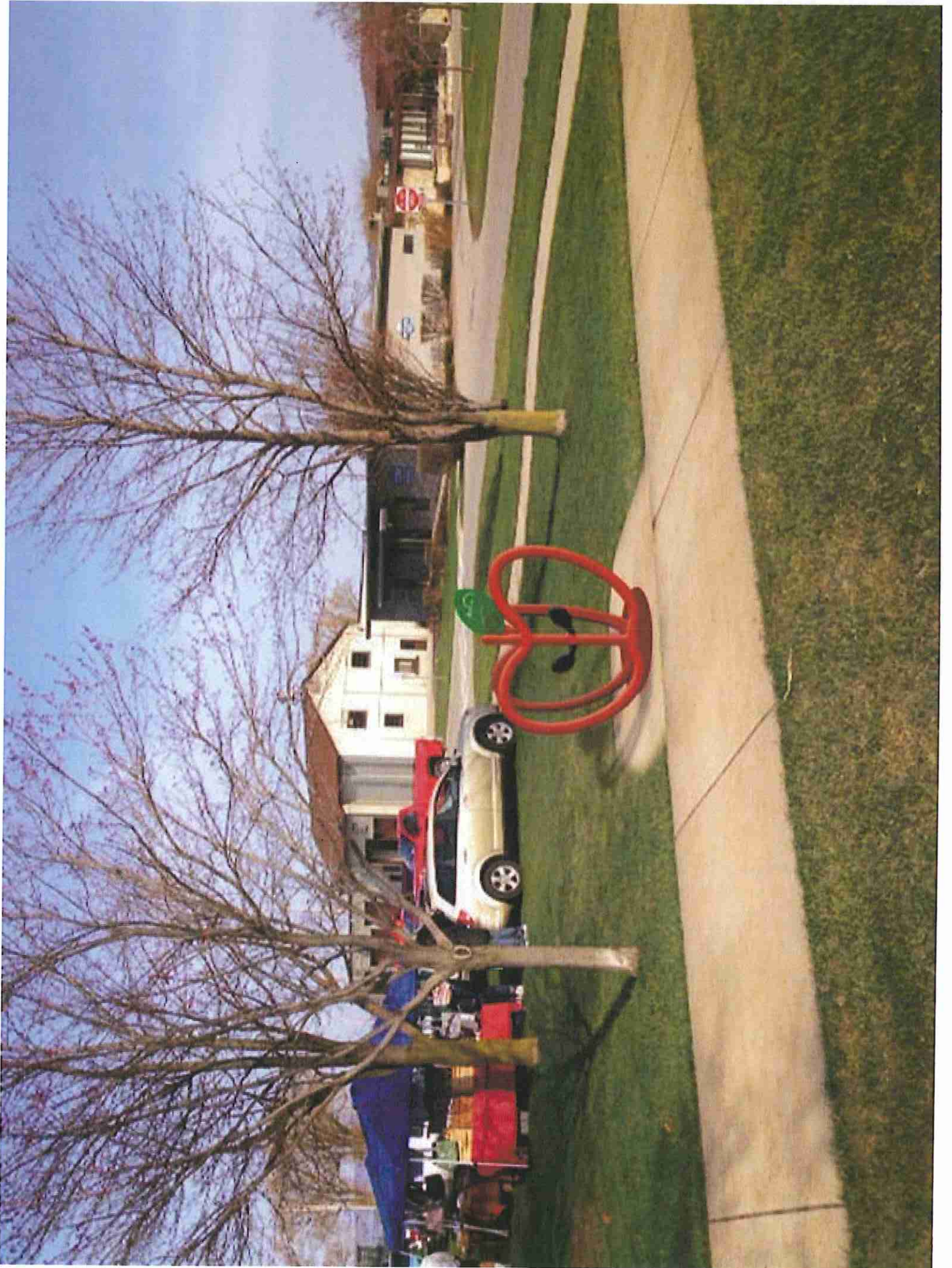

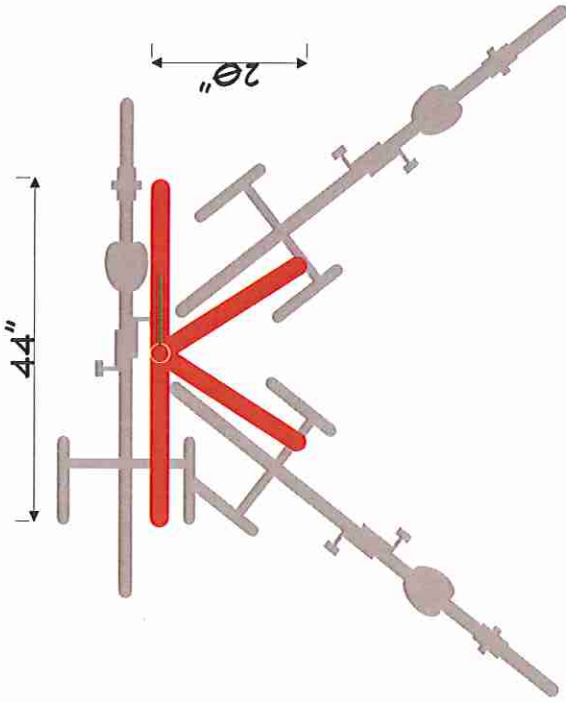
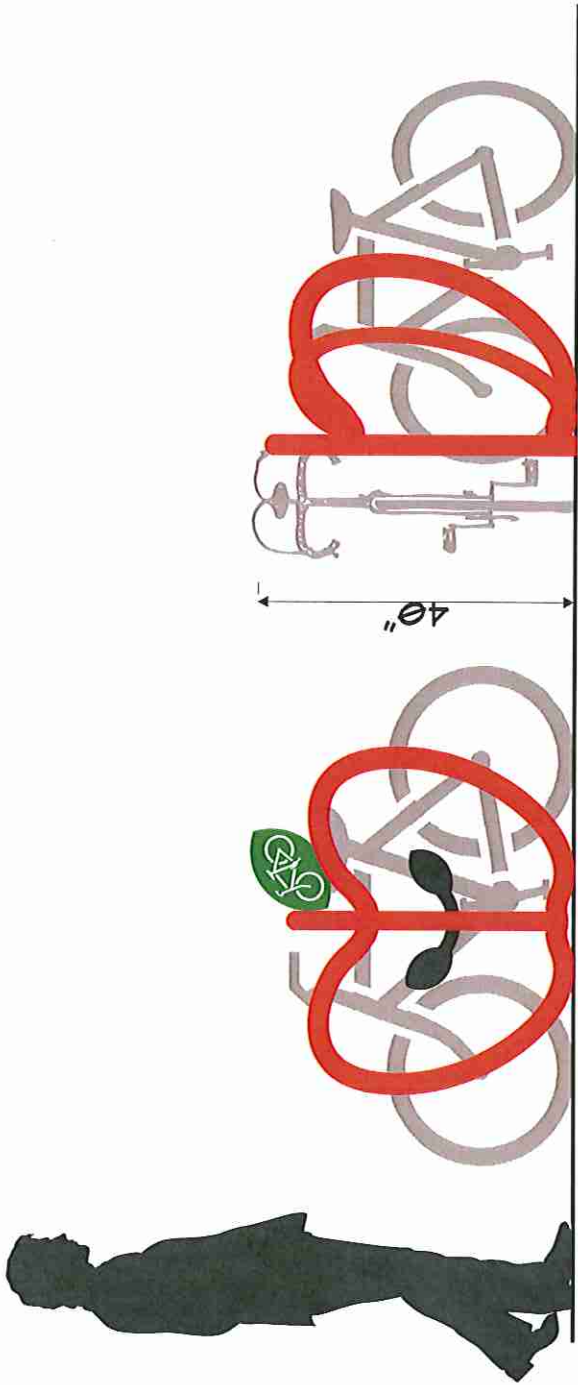

SCALE: 1/2" = 1' 5/1/13



SHOPPING
DINING
PUBLIC BEACH
BOSTON FERRY
ADAMANTHI PARK

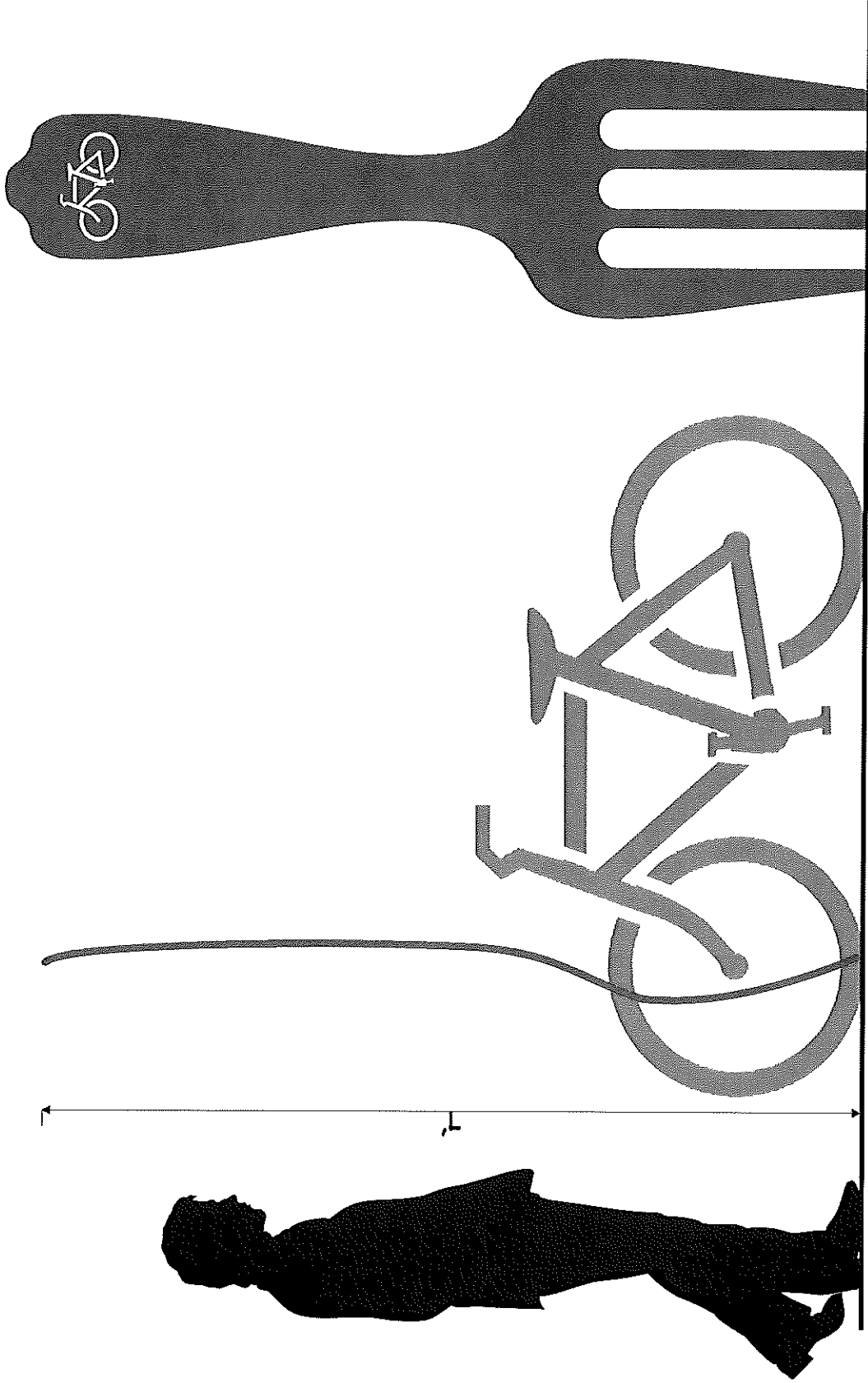

SCALE: 3/4" = 1' 5/1/13

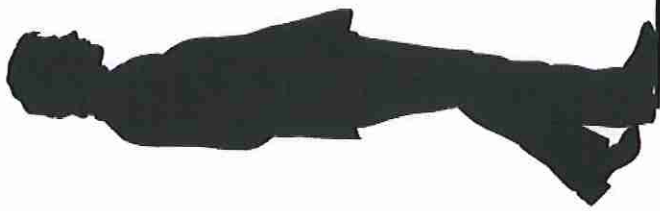

34"

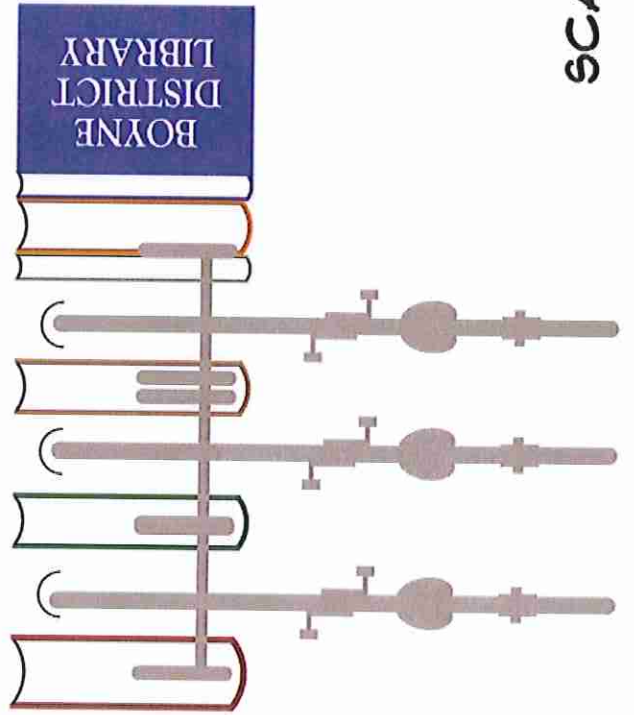
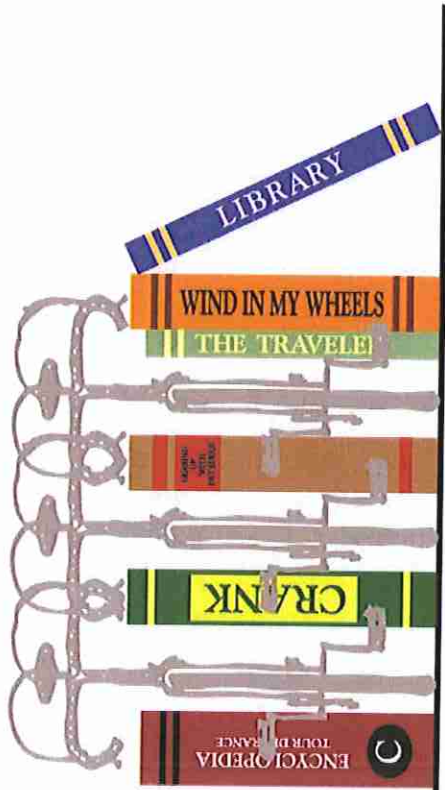

SCALE: 1/2" = 1' 5/1/13





SCALE: 3/4" = 1' 5/1/13